

Cleco

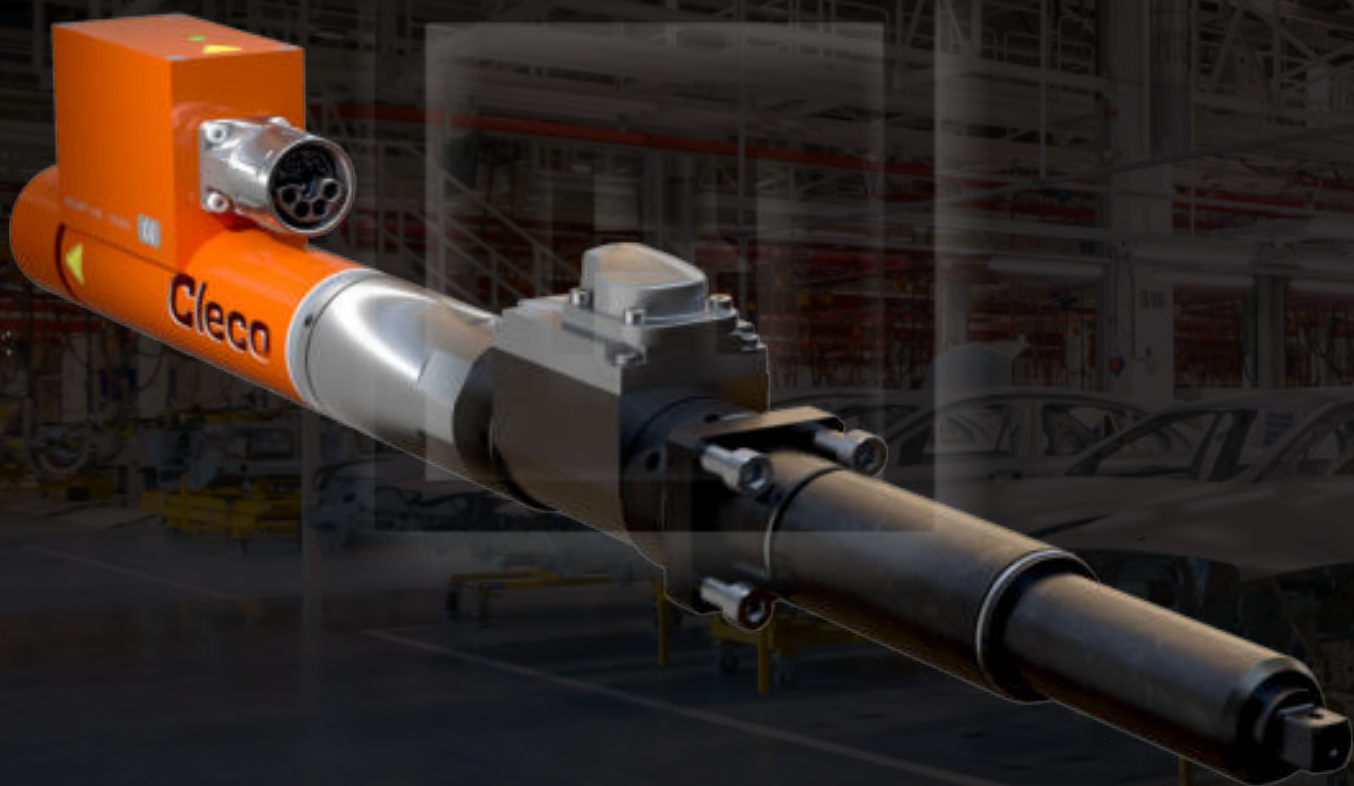

HERMES
TOOLS

Cleco | Tame the Line

FIXTURED SPINDLES

**KNOWN FOR DURABILITY.
TRUSTED FOR QUALITY.**

**THE ULTIMATE AUTOMATED
TIGHTENING SOLUTIONS.**

Cleco DGD™ Intelligent Spindles are the exclusive fixtured assembly solution, combining reduced floor space, fewer cables and high-speed uptime availability for automated fastening applications. Intelligent spindles provide a wide range of torque capability and industry-leading free speeds.



**REDUCE YOUR FOOTPRINT AND
TOTAL COST OF OWNERSHIP VIA
OUR EXCLUSIVE INTELLIGENT
SPINDLE CABLING TECHNOLOGY.**

When you're looking to run robotic tightening applications, look to Cleco DGD intelligent spindle solutions. By utilizing our exclusive daisy-chain connectors, we offer the only solution in the industry that enables you to run multiple spindles using a daisy-chained cable solution. This results in reduced system complexity, simple cable management and smaller pay-load capacity.



**SAME CELL, SAME ROBOT:
INTELLI-SWAP, AN INDUSTRY FIRST.**

Combining Cleco DGD Intelligent Spindles and daisy-chain connectors with our patented Intelli-Swap system technology, plus an automatic, intelligent tool changer enables your system to rapidly switch from one group of spindles to another using the same controller. Cleco DGD solutions enable you to effortlessly manage multiple applications in a single cell.



Fixtured Spindles

is as simple as 1, 2, 3 !

Conventional Spindle	Single Intelligent Spindle	Intelligent Spindles - Consult Application Center	INTELLIGENT SPINDLES
			Select from catalog. Floating spindle ordered separately.
			mPRO400GCD-P-BTS
			mPRO400GCM PDBCPSXX - Select model from catalog.
			Select cable with desired connector from catalog.
			Select from catalog.
CONVENTIONAL SPINDLES			
			Select from catalog. Floating spindle ordered separately.
			mPRO300GCD-STO, mPRO400GCD-S
			mPRO400GCD
			Select from catalog.
			Select from catalog.
			Select from catalog.
			Select cable with desired connector from catalog.
			Contact application center.

1. Choose a common system to the left
2. Select the components below.
3. Order your system!

Intelligent Fixtured Spindles	
System Control Package Controller, Power Transformer, Power Distribution Box, Arcnet Cable and Stand	
Jumper Extension Cables	
System Bus Terminator at Spindle	
Conventional Fixtured Spindles	
Controller	
Field Bus Accessories & System Bus Cable	
Extension Cables	
Floating Spindle Adaptors	
Field Cables	
Engineered System Fixturing	

Fixtured Spindles

Cleco's Digital (BD) Spindles are engineered to bring you a new level of **performance and productivity**, offering a **best-in-class total cost of ownership**.



Choosing the Correct Spindle

1	B	D	U	53	T1	S	-A
---	---	---	---	----	----	---	----

1	Size = 1-4
B	B = Brushless motor
D	D = Digital design
U	U = U-gear
53	35 Nm max. tool capacity 53 Nm max. tool capacity 110 Nm max. tool capacity
T1	T1 = Single transducer T2 = Twin transducer T3 = Triple transducer
S	S = Straight drive O = Offset drive A = Angle head drive
-A	-A = Spindle revision (ongoing) -Sxxx = Special (xxx = assigned No.)

EXAMPLE:

1	B		D	U	35	T2	S	-A
---	---	--	---	---	----	----	---	----

Conventional spindle #1, U gear, 35 Nm, twin transducers, straight drive, spindle revision A

 Increased productivity through higher free speed

 Seamlessly and easily integrates to all assembly systems

 Increases overall equipment availability through an efficient engineered system

 Ensures accurate and repeatable productivity

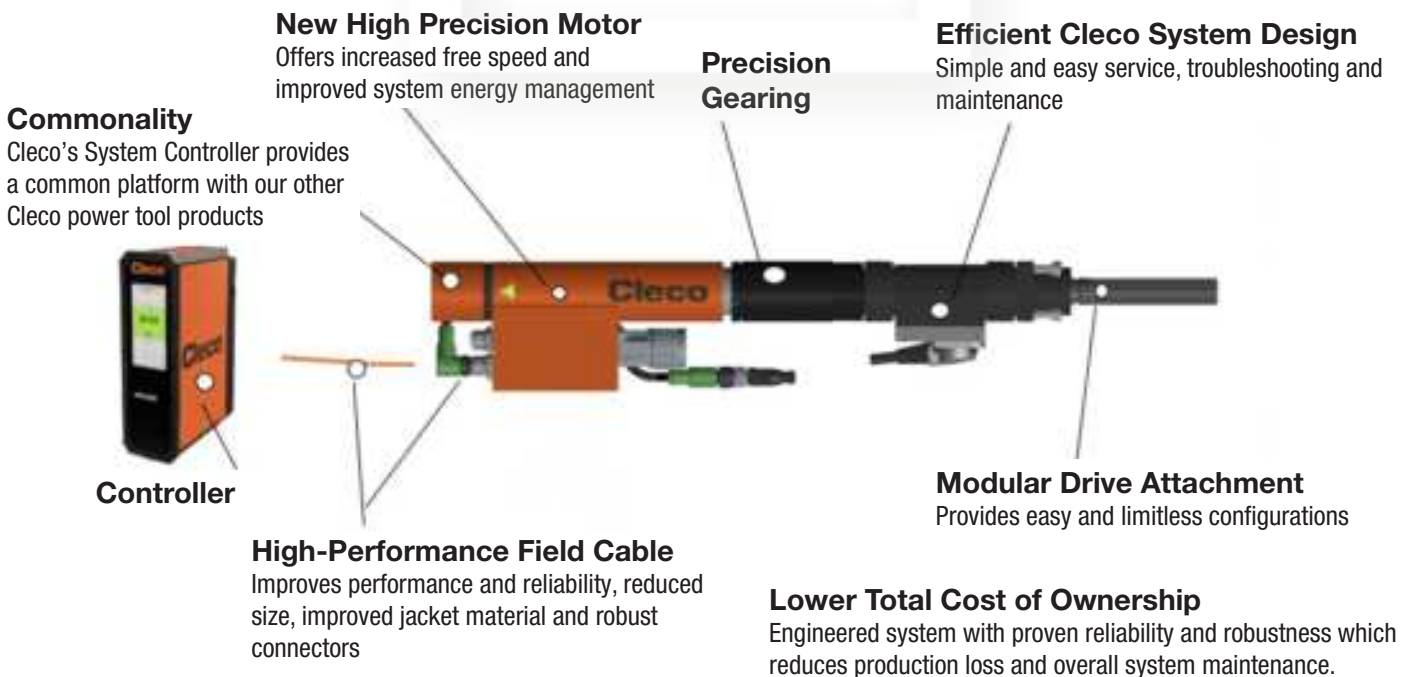

Fixtured Spindles

Cleco's Digital (BD) Spindles are engineered to bring you a new level of performance and productivity, offering a best-in-class total cost of ownership.



- Speed - Increased productivity through higher free speed
- System Simplicity - Seamlessly and easily integrates to all assembly systems
- Reliability - Increases overall equipment availability through an efficient engineered system
- Accuracy - Ensures accurate and repeatable productivity
- Compatible with mPro300GCD-STO Global Controller

Model	Torque Range				Free Speed	Float	Min Center to Center	Weight		Length	
	Min Nm	Max Nm	Min Ft lb	Max Ft lb	r/min	mm	mm	Lb	kg	in	mm
1BD12T1S-A	2	12	1.5	8.9	3317	50	43	7.72	3.5	15.59	396
1BD12T2S-A	2	12	1.5	8.9	3317	50	43	9.04	4.1	18.74	476
1BDU12T1S-A	2	12	1.5	8.9	3317	50	43	8.82	4	9.88	251
1BDU12T2S-A	2	12	1.5	8.9	3317	50	43	10.14	4.6	13.03	331
1BD35T1S-A	3.5	35	2.6	25.8	1255	50	43	7.72	3.5	15.59	396
1BD35T2S-A	3.5	35	2.6	25.8	1255	50	43	9.04	4.1	18.74	476
1BDU35T1S-A	3.5	35	2.6	25.8	1255	50	43	8.82	4	9.88	251
1BDU35T2S-A	3.5	35	2.6	25.8	1255	50	43	10.14	4.6	13.03	331
1BD53T1S-A	5.3	53	3.9	39.1	737	50	43	7.72	3.5	15.59	396
1BD53T2S-A	5.3	53	3.9	39.1	737	50	43	9.04	4.1	18.74	476
1BDU53T1S-A	5.3	53	3.9	39.1	737	50	43	8.82	4	9.88	251
1BDU53T2S-A	5.3	53	3.9	39.1	737	50	43	10.14	4.6	13.03	331

Cleco's Digital (BD) Spindles are engineered to bring you a new level of performance and productivity, offering a best-in-class total cost of ownership.



- Speed - Increased productivity through higher free speed
- System Simplicity - Seamlessly and easily integrates to all assembly systems
- Reliability -
- Increases overall equipment availability through an efficient engineered system
- Accuracy - Ensures accurate and repeatable productivity
- Compatible with mPro300GCD-STO Global Controller

Model	Torque Range				Free Speed	Float	Min Center to Center	Weight		Length	
	Min Nm	Max Nm	Min Ft lb	Max Ft lb	r/min	mm	mm	Lb	kg	in	mm
1BD12T1A-A	2	12	1.5	8.9	3110	25	52	9.7	4.4	16.81	427
1BD12T2A-A	2	12	1.5	8.9	3110	25	52	11.03	5	19.96	507
1BDU12T1A-A	2	12	1.5	8.9	3110	25	52	10.8	4.9	11.10	282
1BDU12T2A-A	2	12	1.5	8.9	3110	25	52	12.13	5.5	14.25	362
1BD35T1A-A	3.5	35	2.6	25.8	1176	25	52	9.7	4.4	16.81	427
1BD35T2A-A	3.5	35	2.6	25.8	1176	25	52	11.03	5	19.96	507
1BDU35T1A-A	3.5	35	2.6	25.8	1176	25	52	10.8	4.9	11.10	282
1BDU35T2A-A	3.5	35	2.6	25.8	1176	25	52	12.13	5.5	14.25	362
1BD53T1A-A	5.3	53	3.9	39.1	691	25	52	9.7	4.4	16.81	427
1BD53T2A-A	5.3	53	3.9	39.1	691	25	52	11.03	5	19.96	507
1BDU53T1A-A	5.3	53	3.9	39.1	691	25	52		4.9		282
1BDU53T2A-A	5.3	53	3.9	39.1	691	25	52	12.13	5.5	14.25	362

Fixtured Spindles

Cleco's Digital (BD) Spindles are engineered to bring you a new level of performance and productivity, offering a best-in-class total cost of ownership.



- Speed - Increased productivity through higher free speed
- System Simplicity - Seamlessly and easily integrates to all assembly systems
- Reliability - Increases overall equipment availability through an efficient engineered system
- Accuracy - Ensures accurate and repeatable productivity
- Compatible with mPro300GCD-STO Global Controller

Model	Torque Range				Free Speed r/min	Float mm	Min Center to Center mm	Weight		Length	
	Min Nm	Max Nm	Min Ft lb	Max Ft lb				Lb	kg	in	mm
1BD12T1O-A	2	12	1.5	8.9	3151	50	35	8.82	4	15.12	384
1BD12T2O-A	2	12	1.5	8.9	3151	50	35	10.14	4.6	18.27	464
1BDU12T1O-A	2	12	1.5	8.9	3151	50	35	9.92	4.5	9.41	239
1BDU12T2O-A	2	12	1.5	8.9	3151	50	35	11.25	5.1	12.56	319
1BD35T1O-A	3.5	35	2.6	25.8	1192	50	35	8.82	4	15.12	384
1BD35T2O-A	3.5	35	2.6	25.8	1192	50	35	10.14	4.6	18.27	464
1BDU35T1O-A	3.5	35	2.6	25.8	1192	50	35	9.92	4.5	9.41	239
1BDU35T2O-A	3.5	35	2.6	25.8	1192	50	35	11.25	5.1	12.56	319
1BD53T1O-A	5.3	53	3.9	39.1	700	50	35	8.82	4	15.12	384
1BD53T2O-A	5.3	53	3.9	39.1	700	50	35	10.14	4.6	18.27	464
1BDU53T1O-A	5.3	53	3.9	39.1	700	50	35	9.92	4.5	9.41	239
1BDU53T2O-A	5.3	53	3.9	39.1	700	50	35	11.25	5.1	12.56	319

Cleco's Digital (BD) Spindles are engineered to bring you a new level of performance and productivity, offering a best-in-class total cost of ownership.



- Speed - Increased productivity through higher free speed
- System Simplicity - Seamlessly and easily integrates to all assembly systems
- Reliability - Increases overall equipment availability through an efficient engineered system
- Accuracy - Ensures accurate and repeatable productivity
- Compatible with mPro300GCD-STO Global Controller

Model	Torque Range				Free Speed r/min	Float mm	Min Center to Center mm	Weight		Length	
	Min Nm	Max Nm	Min Ft lb	Max Ft lb				Lb	kg	in	mm
2BD110T1S-A	11	110	8.1	81.1	890	50	56	14.33	6.5	18.94	481
2BD110T2S-A	11	110	8.1	81.1	890	50	56	16.76	7.6	22.76	578
2BDU110T1S-A	11	110	8.1	81.1	890	50	56	16.54	7.5	12.2	310
2BDU110T2S-A	11	110	8.1	81.1	890	50	56	18.96	8.6	16.02	407
2BD200T1S-A	20	200	14.8	147.5	501	50	56	14.33	6.5	18.94	481
2BD200T2S-A	20	200	14.8	147.5	501	50	56	16.76	7.6	22.76	578
2BDU200T1S-A	20	200	14.8	147.5	501	50	56	16.54	7.5	12.2	310
2BDU200T2S-A	20	200	14.8	147.5	501	50	56	18.96	8.6	16.02	407

Fixtured Spindles

Cleco's Digital (BD) Spindles are engineered to bring you a new level of performance and productivity, offering a best-in-class total cost of ownership.



- Speed - Increased productivity through higher free speed
- System Simplicity - Seamlessly and easily integrates to all assembly systems
- Reliability - Increases overall equipment availability through an efficient engineered system
- Accuracy - Ensures accurate and repeatable productivity
- Compatible with mPro300GCD-STO Global Controller

Model	Torque Range				Free Speed r/min	Float mm	Min Center to Center mm	Weight		Length	
	Min Nm	Max Nm	Min Ft lb	Max Ft lb				Lb	kg	in	mm
2BD110T1A-A	11	110	8.1	81.1	837	25	59	16.76	7.6	19.88	505
2BD110T2A-A	11	110	8.1	81.1	837	25	59	19.18	8.7	23.7	602
2BDU110T1A-A	11	110	8.1	81.1	837	25	59	18.96	8.6	13.19	335
2BDU110T2A-A	11	110	8.1	81.1	837	25	59	21.39	9.7	17.01	432
2BD200T1A-A	20	200	14.8	147.5	472	25	59	16.76	7.6	19.88	505
2BD200T2A-A	20	200	14.8	147.5	472	25	59	19.18	8.7	23.7	602
2BDU200T1A-A	20	200	14.8	147.5	472	25	59	18.96	8.6	13.19	335
2BDU200T2A-A	20	200	14.8	147.5	472	25	59	21.39	9.7	17.01	432

Cleco's Digital (BD) Spindles are engineered to bring you a new level of performance and productivity, offering a best-in-class total cost of ownership.



- Speed - Increased productivity through higher free speed
- System Simplicity - Seamlessly and easily integrates to all assembly systems
- Reliability - Increases overall equipment availability through an efficient engineered system
- Accuracy - Ensures accurate and repeatable productivity
- Compatible with mPro300GCD-STO Global Controller

Model	Torque Range				Free Speed r/min	Float mm	Min Center to Center mm	Weight		Length	
	Min Nm	Max Nm	Min Ft lb	Max Ft lb				Lb	kg	in	mm
2BD110T1O-A	11	110	8.1	81.1	830	50	44	17.86	8.1	19.84	504
2BD110T2O-A	11	110	8.1	81.1	830	50	44	20.29	9.2	23.66	601
2BDU110T1O-A	11	110	8.1	81.1	830	50	44	20.07	9.1	13.11	333
2BDU110T2O-A	11	110	8.1	81.1	830	50	44	22.49	10.2	16.93	430
2BD200T1O-A	20	200	14.8	147.5	468	50	44	17.86	8.1	19.84	504
2BD200T2O-A	20	200	14.8	147.5	468	50	44	19.18	9.2	23.66	601
2BDU200T1O-A	20	200	14.8	147.5	468	50	44	20.07	9.1	13.11	333
2BDU200T2O-A	20	200	14.8	147.5	468	50	44	22.49	10.2	16.93	430

Fixtured Spindles

Cleco's Digital (BD) Spindles are engineered to bring you a new level of performance and productivity, offering a best-in-class total cost of ownership.



- Speed - Increased productivity through higher free speed
- System Simplicity - Seamlessly and easily integrates to all assembly systems
- Reliability - Increases overall equipment availability through an efficient engineered system
- Accuracy - Ensures accurate and repeatable productivity
- Compatible with mPro300GCD-STO Global Controller

Model	Torque Range				Free Speed	Float	Min Center to Center	Weight		Length	Length
	Min Nm	Max Nm	Min Ft lb	Max Ft lb	r/min	mm	mm	Lb	kg	in	mm
3BD300T1S-A	30	300	22.1	221.3	480	50	81	28.89	13.1	21.97	558
3BD300T2S-A	30	300	22.1	221.3	480	50	81	33.52	15.2	26.38	670
3BDU300T1S-A	30	300	22.1	221.3	480	50	81	33.3	15.1	14.41	366
3BDU300T2S-A	30	300	22.1	221.3	480	50	81	37.93	17.2	18.82	478

Cleco's Digital (BD) Spindles are engineered to bring you a new level of performance and productivity, offering a best-in-class total cost of ownership.



- Speed - Increased productivity through higher free speed
- System Simplicity - Seamlessly and easily integrates to all assembly systems
- Reliability - Increases overall equipment availability through an efficient engineered system
- Accuracy - Ensures accurate and repeatable productivity
- Compatible with mPro300GCD-STO Global Controller

Model	Torque Range				Free Speed	Float	Min Center to Center	Weight		Length	Length
	Min Nm	Max Nm	Min Ft lb	Max Ft lb	r/min	mm	mm	Lb	kg	in	mm
3BD300T1A-A	30	300	22.1	221.3	462	25	81	37.04	16.8	23.9	607
3BD300T2A-A	30	300	22.1	221.3	462	25	81	41.67	18.9	28.31	719
3BDU300T1A-A	30	300	22.1	221.3	462	25	81	41.45	18.8	16.34	415
3BDU300T2A-A	30	300	22.1	221.3	462	25	81	46.08	20.9	20.75	527

Fixtured Spindles

Cleco's Digital (BD) Spindles are engineered to bring you a new level of performance and productivity, offering a best-in-class total cost of ownership.



- Speed - Increased productivity through higher free speed
- System Simplicity - Seamlessly and easily integrates to all assembly systems
- Reliability - Increases overall equipment availability through an efficient engineered system
- Accuracy - Ensures accurate and repeatable productivity
- Compatible with mPro300GCD-STO Global Controller

Model	Torque Range				Free Speed r/min	Float mm	Min Center to Center mm	Weight		Length	
	Min Nm	Max Nm	Min Ft lb	Max Ft lb				Lb	kg	in	mm
3BD300T1O-A	30	300	22.1	221.3	445	50	59	31.31	14.2	21.77	553
3BD300T2O-A	30	300	22.1	221.3	445	50	59	35.94	16.3	26.18	665
3BDU300T1O-A	30	300	22.1	221.3	445	50	59	35.5	16.1	14.21	361
3BDU300T2O-A	30	300	22.1	221.3	445	50	59	40.13	18.2	18.62	473

Cleco's Digital (BD) Spindles are engineered to bring you a new level of performance and productivity, offering a best-in-class total cost of ownership.



- Speed - Increased productivity through higher free speed
- System Simplicity - Seamlessly and easily integrates to all assembly systems
- Reliability - Increases overall equipment availability through an efficient engineered system
- Accuracy - Ensures accurate and repeatable productivity
- Compatible with mPro300GCD-STO Global Controller

Model	Torque Range				Free Speed r/min	Float mm	Min Center to Center mm	Weight		Length	
	Min Nm	Max Nm	Min Ft lb	Max Ft lb				Lb	kg	in	mm
4BD500T1S-A	50	500	36.9	368.8	269	50	91	44.1	20	27.13	689
4BD500T2S-A	50	500	36.9	368.8	269	50	91	50.72	23	32.17	817
4BDU500T1S-A	50	500	36.9	368.8	269	50	91	47.41	21.5	19.57	497
4BDU500T2S-A	50	500	36.9	368.8	269	50	91	54.02	24.5	24.61	625
4BD660T1S-A	66	660	48.7	486.8	183	50	91	44.1	20	27.13	689
4BD660T2S-A	66	660	48.7	486.8	183	50	91	50.72	23	32.17	817
4BDU660T1S-A	66	660	48.7	486.8	183	50	91	47.41	21.5	19.57	497
4BDU660T2S-A	66	660	48.7	486.8	183	50	91	54.02	24.5	24.61	625
4BD1250T1S-A	320	1250	236.0	922.0	91	50	121	61.74	28	29.21	742
4BD1250T2S-A	320	1250	236.0	922.0	91	50	121	68.36	31	34.17	868
4BDU1250T1S-A	320	1250	236.0	922.0	91	50	121	66.15	30	21.65	550
4BDU1250T2S-A	320	1250	236.0	922.0	91	50	121	72.77	33	26.65	677
4BD1600T1S-A	400	1600	295.0	1180.1	72	50	121	61.74	28	29.21	742
4BD1600T2S-A	400	1600	295.0	1180.1	72	50	121	68.36	31	34.17	868
4BDU1600T1S-A	400	1600	295.0	1180.1	72	50	121	66.15	30	21.65	550
4BDU1600T2S-A	400	1600	295.0	1180.1	72	50	121	72.77	33	26.65	677
4BD2800T1S-A	980	2800	722.8	2065.2	39			78.28	35.5	28.94	735
4BD2800T2S-A	980	2800	722.8	2065.2	39			84.89	38.5	33.94	862
4BDU2800T1S-A	980	2800	722.8	2065.2	39			82.69	37.5	22.36	568
4BDU2800T2S-A	980	2800	722.8	2065.2	39			89.3	40.5	27.4	696

Fixtured Spindles

Cleco's Digital (BD) Spindles are engineered to bring you a new level of performance and productivity, offering a best-in-class total cost of ownership.

- Speed - Increased productivity through higher free speed
- System Simplicity - Seamlessly and easily integrates to all assembly systems
- Reliability - Increases overall equipment availability through an efficient engineered system
- Accuracy - Ensures accurate and repeatable productivity
- Compatible with mPro300GCD-STO Global Controller



Model	Torque Range				Free Speed	Float	Min Center to Center	Weight		Length	
	Min Nm	Max Nm	Min Ft lb	Max Ft lb	r/min	mm	mm	Lb	kg	in	mm
4BD500T1A-A	50	500	36.9	368.8	259	25	112	57.55	26.1	25.39	645
4BD500T2A-A	50	500	36.9	368.8	259	25	112	64.17	29.1	30.39	772
4BDU500T1A-A	50	500	36.9	368.8	259	25	112	61.08	27.7	17.83	453
4BDU500T2A-A	50	500	36.9	368.8	259	25	112	67.69	30.7	22.83	580
4BD660T1A-A	66	660	48.7	486.8	177	25	112	57.55	26.1	25.39	645
4BD660T2A-A	66	660	48.7	486.8	177	25	112	64.17	29.1	30.39	772
4BDU660T1A-A	66	660	48.7	486.8	177	25	112	61.08	27.7	17.83	453
4BDU660T2A-A	66	660	48.7	486.8	177	25	112	67.69	30.7	22.83	580

Cleco's Digital (BD) Spindles are engineered to bring you a new level of performance and productivity, offering a best-in-class total cost of ownership.



- Speed - Increased productivity through higher free speed
- System Simplicity - Seamlessly and easily integrates to all assembly systems
- Reliability - Increases overall equipment availability through an efficient engineered system
- Accuracy - Ensures accurate and repeatable productivity
- Compatible with mPro300GCD-STO Global Controller

Model	Torque Range				Free Speed r/min	Float mm	Min Center to Center mm	Weight		Length	
	Min Nm	Max Nm	Min Ft lb	Max Ft lb				Lb	kg	in	mm
4BD500T1O-A	50	500	36.9	368.8	252	50	76	47.41	21.5	25.79	655
4BD500T2O-A	50	500	36.9	368.8	252	50	76	54.02	24.5	30.79	782
4BDU500T1O-A	50	500	36.9	368.8	252	50	76	50.72	23	18.23	463
4BDU500T2O-A	50	500	36.9	368.8	252	50	76	57.33	26	23.23	590
4BD660T1O-A	66	660	48.7	486.8	172	50	76	47.41	21.5	25.79	655
4BD660T2O-A	66	660	48.7	486.8	172	50	76	54.02	24.5	30.79	782
4BDU660T1O-A	66	660	48.7	486.8	172	50		50.72	23	18.23	463
4BDU660T2O-A	66	660	48.7	486.8	172	50	76	57.33	26	23.23	590
4BD750T1O-A	75	750	55.3	553.2	143	50	76	48.51	22	25.79	655
4BD750T2O-A	75	750	55.3	553.2	143	50	76	55.13	25	30.79	782
4BDU750T1O-A	75	750	55.3	553.2	143	76	76	58.43	26.5	23.23	590
4BDU750T2O-A	75	750	55.3	553.2	143	50	76	58.43	26.5	23.23	590

Fixtured Spindles

Mini-Spindles are the **compact solution for low-torque applications** in automatic or semi-automatic machine or robotic assembly station.

Choosing the Correct Spindle



30	M	A	D	28	P3	E	G	-S	1	001
----	---	---	---	----	----	---	---	----	---	-----

30	30 - Motorunit 0,9Nm 50 - Motorunit 2,1Nm
M	B = Minispindle
A	A = Angle O= Offset S= Straight T= Tubenut C= Crowfoot
D	D = Digital design
28	28 = max. tool capacity 28 Nm 35 = max. tool capacity 35 Nm 51 = max. tool capacity 51 Nm etc.
P3	P3 = spiral geared AH 3/8"
E	E= Electronic for 2nd Transducer
G	G= Thread in angle head for attachment
-S	- S = Special with ATG Components - C = Special with Customer Components
1	- = Standard -L = turned AH left side -R = turned AH right side -180 = turned AH 180 degrees (Nomenclature of Standard tools ends here)
001	Only used if Special Tool: 001 = ongoing No. Drive Component delivered by: 0 = Apex 1 = Lübbering 2 = free 3 = free 4 = free 5 = free 6 = free 7 = free 8 = free 9 = free

- Intelligent and compact solution for low-torque applications in automatic or semi-automatic assembly (fixed automation or robot)
- Built-in mounting provisions for ease of fixturing
- Lightweight



Model	Torque Range				Free Speed r/min	Weight		Length	
	Min Nm	Max Nm	Min Ft lb	Max Ft lb		Lb	kg	in	mm
30MSD10D3E	3	10	2.2	7.4	1425	2.64	1.2	7.37	187.1
30MSD15D3E	4	15	3.0	11.1	1075	2.64	1.2	7.59	192.9
50MSD32D3E	9	32	6.6	23.6	770	3.52	1.6	9.36	237.7

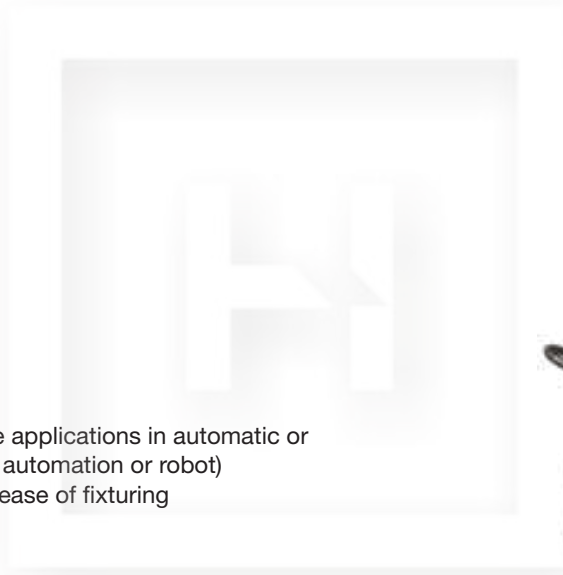

- Compact solution for low-torque applications in automatic or semi-automatic assembly (fixed automation or robot)
- Built-in mounting provisions for ease of fixturing
- Lightweight



Model	Torque Range				Free Speed r/min	Weight		Length	
	Min Nm	Max Nm	Min Ft lb	Max Ft lb		Lb	kg	in	mm
30MAD28P3E	7	28	5.2	20.7	495	3.74	1.7	10.12	257.1
30MAD38P3E	8	38	5.9	28.0	495	3.96	1.8	10.21	259.3
50MAD51P3E	14	51	10.3	37.6	920	4.84	2.2	12.0	304.8
50MAD61P3E	16	61	11.8	45.0	800	5.06	2.3	12.31	312.8

Fixtured Spindles

With straight drive, offset drive, and angle drive configurations, each available with reversible gears, and four different motor sizes to suit different torque requirements, there's an Intelligent Spindle to fit most any situation. Your Apex Tool Group Technical Sales Representative will work with you to determine the best solution for you. We can also provide you with application assistance in automation integration, joint analysis testing, complex data connection, and more.

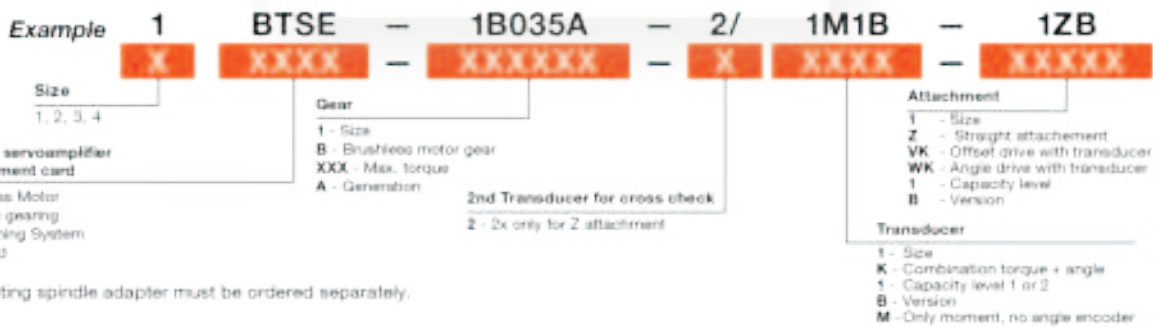

Intelligent Spindle Sizes and Torque Ranges



On board servo module, Patented daisy chain, Torque transducer, Angle Encoder, modular construction

- Long Service Life, Maximum Precision, High Accuracy, World class free speed, On-Board trouble shooting
- Floating adapter not included with spindle



Model	Torque Range				Free Speed r/min	Float mm	Drive Type	Min Center to Center mm	Weight		Length	
	Min Nm	Max Nm	Min Ft lb	Max Ft lb					Lb	kg	in	mm
947541A8	2	12	1.48	8.9	1921	50	3/8" Square Drive	43	10.6	4.8	19.1	486
947553A4	5	35	3.69	25.8	727	50	3/8" Square Drive	43	10.6	4.8	19.1	486
947565A0	15	53	11.1	39.1	427	50	3/8" Square Drive	43	10.6	4.8	19.1	486
947517A8	25	110	18.5	81	890	50	1/2" Square Drive	56	16.8	7.6	20.8	528
947529A4	40	200	29.5	148	502	50	3/4" Square Drive	56	16.8	7.6	20.8	528
947577A6	50	300	36.9	221	453	50	3/4" Square Drive	81	31.1	14.1	23.2	589
947589A2	100	500	74	369	254	50	3/4" Square Drive	91	46.3	21	28.3	719
947601A5	130	660	96	487	174	50	1" Square Drive	91	46.3	21	28.3	719
947617A71	320	1250	236	921	86	50	1" Square Drive	121	64	29	30.4	771
947621A11	400	1600	295	1180	68	50	1-1/2" Square Drive	121	64	29	30.4	771

On board servo module, Patented daisy chain, Torque transducer, modular construction

- Long Service Life, Maximum Precision, High Accuracy, World class free speed, On-Board trouble shooting
- Floating adapter not included with spindle



Model	Torque Range				Free Speed r/min	Float mm	Drive Type	Min Center to Center mm	Weight		Length	
	Min Nm	Max Nm	Min Ft lb	Max Ft lb					Lb	kg	in	mm
947626A6	2	12	1.48	8.85	1921	50	3/8" Square Drive	43	10.6	5.3	19.1	393
947632A8	5	35	1.48	25.8	727	50	3/8" Square Drive	43	10.6	5.3	19.1	393
947638A2	15	53	11.1	39.1	427	50	3/8" Square Drive	43	10.6	5.3	19.1	393
947644A4	25	110	18.4	81.1	890	50	3/8" Square Drive	56	16.8	8.6	20.8	367
947650A6	40	200	29.5	146	502	50	3/8" Square Drive	56	16.8	8.6	20.8	367
947656A0	50	300	36.9	221	453	50	3/8" Square Drive	81	31.1	16.1	23.2	417
947662A2	100	500	73.8	369	254	50	3/8" Square Drive	91	46.3	22.5	28.3	546
947668A6	130	660	95.9	487	174	50	3/8" Square Drive	91	46.3	22.5	28.3	546
947676A6	320	1250	236	922	86	50	3/8" Square Drive	121	64	31	30.4	599
947677A5	400	1600	295	1180	68	50	3/8" Square Drive	121	64	31	30.4	599
947681A9	980	2800	773	2065	37	50	3/8" Square Drive	160	88	39.73	31.1	790

Fixtured Spindles

On board servo module, Patented daisy chain, Twin Torque transducer, Angle Encoder, Modular construction

- Long Service Life, Maximum Precision, High Accuracy, World class free speed, On-Board trouble shooting
- Floating adapter not included with spindle



Model	Torque Range				Free Speed r/min	Float mm	Drive Type	Min Center to Center mm	Weight		Length	
	Min Nm	Max Nm	Min Ft lb	Max Ft lb					Lb	kg	in	mm
947542A7	2	12	1.48	8.9	1921	50	3/8" Square Drive	43	11.9	5.4	22.3	566
947554A3	5	35	3.69	25.8	727	50	3/8" Square Drive	43	11.9	5.4	22.3	566
947566A9	15	53	11.1	39.1	427	50	3/8" Square Drive	43	11.9	5.4	22.3	566
947518A7	25	110	18.5	81	890	50	1/2" Square Drive	56	19.2	8.7	24.6	625
947530A1	40	200	29.5	148	502	50	3/4" Square Drive	56	19.2	8.7	24.6	625
947578A5	50	300	36.9	221	453	50	3/4" Square Drive	81	35.7	16.2	27.6	701
947590A9	100	500	74	369	254	50	3/4" Square Drive	91	53	24	33.3	846
947602A4	130	660	96	487	174	50	1" Square Drive	91	53	24	33.3	846
947618A61	320	1250	236	922	86	50	1" Square Drive	121	71	32	35.4	899
947622A01	400	1600	295	1180	68	50	1-1/2" Square Drive	121	71	32	35.4	899

On board servo module, Patented daisy chain, Twin Torque transducer, Twin Angle Encoder

- Long Service Life, Maximum Precision, High Accuracy, World class free speed, On-Board trouble shooting
- Floating adapter not included with spindle



Model	Torque Range				Free Speed r/min	Float mm	Drive Type	Min Center to Center mm	Weight		Length	
	Min Nm	Max Nm	Min Ft lb	Max Ft lb					Lb	kg	in	mm
947544A5	2	12	1.48	8.9	1825	50	3/8" Square Drive	35	13	5.9	21.8	554
947556A1	5	35	3.69	25.8	690	50	3/8" Square Drive	35	13	5.9	21.8	554
947568A7	15	53	11.1	39.1	405	50	3/8" Square Drive	35	13	5.9	21.8	554
947522A1	25	110	18.5	81	831	50	1/2" Square Drive	44	22.7	10.3	25.5	648
947534A7	40	200	29.5	148	468	50	3/4" Square Drive	44	22.7	10.3	25.5	648
947580A1	50	300	36.9	221	421	50	3/4" Square Drive	59	38.1	17.3	27.4	696
947592A7	100	500	74	369	238	50	3/4" Square Drive	76	56	25.5	32	812
947604A2	130	660	96	487	163	50	1" Square Drive	76	56	25.5	32	812
947608A8	160	750	118	554	135	50	1" Square Drive	76	57	26	32	812

On board servo module, Patented daisy chain, Single Torque Transducer, Angle Encoder, Modular construction

- Long Service Life, Maximum Precision, High Accuracy, World class free speed, On-Board trouble shooting
- Floating adapter not included with spindle



Model	Torque Range				Free Speed r/min	Float mm	Drive Type	Min Center to Center mm	Weight		Length	
	Min Nm	Max Nm	Min Ft lb	Max Ft lb					Lb	kg	in	mm
947543A6	2	12	1.48	8.9	1825	50	3/8" Square Drive	35	11.7	5.3	18.7	474
947555A2	5	35	3.69	25.8	690	50	3/8" Square Drive	35	11.7	5.3	18.7	474
947567A8	15	53	11.1	39.1	405	50	3/8" Square Drive	35	11.7	5.3	18.7	474
947521A2	25	110	18.5	81	831	50	1/2" Square Drive	44	20.3	9.2	21.7	551
947533A8	40	200	29.5	148	468	50	3/4" Square Drive	44	20.3	9.2	21.7	551
947579A4	50	300	36.9	221	421	50	3/4" Square Drive	59	33.5	15.2	23	584
947591A8	100	500	74	369	238	50	3/4" Square Drive	76	50	22.5	26.9	684
947603A3	130	660	96	487	163	50	1" Square Drive	76	50	22.5	26.9	684
947607A9	160	750	118	554	135	50	1" Square Drive	76	51	23	26.9	684

On board servo module, Patented daisy chain, Torque transducer, modular construction

- Long Service Life, Maximum Precision, High Accuracy, World class free speed, On-Board trouble shooting
- Floating adapter not included with spindle



Model	Torque Range				Free Speed r/min	Float mm	Drive Type	Min Center to Center mm	Weight		Length	
	Min Nm	Max Nm	Min Ft lb	Max Ft lb					Lb	kg	in	mm
947627A5	2	12	1.48	8.85	1801	50	3/8" Square Drive	35	11.7	5.7	18.7	542
947633A7	5	35	3.69	25.8	681	50	3/8" Square Drive	35	11.7	5.7	18.7	542
947639A1	15	53	11.1	39.1	400	50	3/8" Square Drive	35	11.7	5.7	18.7	542
947645A3	25	110	18.4	81.1	838	50	3/8" Square Drive	44	20.3	8.7	21.7	581
947651A5	40	200	29.5	146	472	50	3/8" Square Drive	44	20.3	8.7	21.7	581
947657A9	50	300	36.9	221	437	50	3/4" Square Drive	59	33.5	17.8	23	629
947633A1	100	500	73.8	369	245	50	3/4" Square Drive	76	50	27.1	26.9	729
947669A5	130	660	95.9	487	167	50	1" Square Drive	76	50	27.1	26.9	729
947671A1	160	750	118	553	135	50	1" Square Drive	76	51	23	26.9	729

Fixtured Spindles

On board servo module, Patented daisy chain, Twin Torque transducer, TwinAngle Encoder, Modular construction

- Long Service Life, Maximum Precision, High Accuracy, World class free speed, On-Board trouble shooting
- Floating adapter not included with spindle



Model	Torque Range				Free Speed r/min	Float mm	Drive Type	Min Center to Center mm	Weight		Length	
	Min Nm	Max Nm	Min Ft lb	Max Ft lb					Lb	kg	in	mm
947545A4	2	12	1.48	8.9	1801	25	3/8" Square Drive	52	12.6	5.7	21.3	542
947557A0	5	35	3.69	25.8	681	25	3/8" Square Drive	52	12.6	5.7	21.3	542
947569A6	15	53	11.1	39.1	400	25	3/8" Square Drive	52	12.6	5.7	21.3	542
947525A8	25	110	18.5	81	838	25	1/2" Square Drive	59	19.2	8.7	22.9	581
947537A4	40	200	29.5	148	472	25	3/4" Square Drive	59	19.2	8.7	22.9	581
947581A0	50	300	36.9	221	437	25	3/4" Square Drive	81	39.2	17.8	26.7	678
947593A6	100	500	74	369	245	25	1" Square Drive	112	60	27.1	28.7	729
947605A1	130	660	96	487	167	25	1" Square Drive	112	60	27.1	28.7	729

On board servo module, Patented daisy chain, Torque transducer, modular construction

- Long Service Life, Maximum Precision, High Accuracy, World class free speed, On-Board trouble shooting
- Floating adapter not included with spindle



Model	Torque Range				Free Speed r/min	Float mm	Drive Type	Min Center to Center mm	Weight		Length	
	Min Nm	Max Nm	Min Ft lb	Max Ft lb					Lb	kg	in	mm
947628A4	2	12	1.48	8.85	1801	25	3/8" Square Drive	52	12.6	5.7	21.3	542
947634A6	5	35	3.69	25.8	681	25	3/8" Square Drive	52	12.6	5.7	21.3	542
947640A8	15	53	11.1	39.1	400	25	3/8" Square Drive	52	12.6	5.7	21.3	542
947646A2	25	110	18.4	81.1	838	25	1/2" Square Drive	59	19.2	8.7	22.9	581
947652A4	40	200	29.5	146	472	25	3/4" Square Drive	59	19.2	8.7	22.9	581
947658A8	50	300	36.9	221	437	25	3/4" Square Drive	81	39.2	17.8	26.7	678
947664A0	100	500	73.8	369	245	25	1" Square Drive	112	60	27.1	28.7	729
947670A2	130	660	95.9	487	167	25	1" Square Drive	112	60	27.1	28.7	729

On board servo module, Patented daisy chain, Twin Torque transducer, Angle Encoder

- Long Service Life, Maximum Precision, High Accuracy, World class free speed, On-Board trouble shooting
- Floating adapter not included with spindle



Model	Torque Range				Free Speed r/min	Float mm	Drive Type	Min Center to Center mm	Weight		Length	
	Min Nm	Max Nm	Min Ft lb	Max Ft lb					Lb	kg	in	mm
947546A3	2	12	1.48	8.9	1801	25	3/8" Square Drive	52	13.9	6.3	24.5	622
947558A9	5	35	3.69	25.8	681	25	3/8" Square Drive	52	13.9	6.3	24.5	622
947570A3	15	53	11.1	39.1	400	25	3/8" Square Drive	52	13.9	6.3	24.5	622
947526A7	25	110	18.5	81	838	25	1/2" Square Drive	59	21.6	9.8	26.7	678
947538A3	40	200	29.5	148	472	25	3/4" Square Drive	59	21.6	9.8	26.7	678
947582A9	50	300	36.9	221	437	25	3/4" Square Drive	81	43.9	19.9	31.1	790
947594A5	100	500	74	369	245	25	1" Square Drive	112	66	30.1	33.7	856
947606A0	130	660	96	487	167	25	1" Square Drive	112	66	30.1	33.7	856

- The transducer can be rotated for crowded multiple spindle arrangements (DGD 15° radial toothing).
- Floating adapter not included with spindle



Model	Torque Range				Free Speed r/min	Float mm	Drive Type	Min Center to Center mm	Weight		Length	
	Min Nm	Max Nm	Min Ft lb	Max Ft lb					Lb	kg	in	mm
947547A2	2	12	1.48	8.9	1921	50	3/8" Square Drive	43	11.7	5.3	15.5	393
947559A8	5	35	3.69	25.8	727	50	3/8" Square Drive	43	11.7	5.3	15.5	393
947571A2	15	53	11.1	39.1	427	50	3/8" Square Drive	43	11.7	5.3	15.5	393
947519A6	25	110	18.5	81	890	50	1/2" Square Drive	56	19	8.6	14.4	367
947531A0	40	200	29.5	148	502	50	3/4" Square Drive	56	19	8.6	14.4	367
947583A8	50	300	36.9	221	453	50	3/4" Square Drive	81	35.5	16.1	16.4	417
947595A4	100	500	74	369	254	50	3/4" Square Drive	91	50	22.5	21.5	546
947609A7	130	660	96	487	174	50	1" Square Drive	91	50	22.5	21.5	546
947619A51	320	1250	236	922	86	50	1" Square Drive	121	68	31	23.6	599
947623A91	400	1600	295	1180	68	50	1-1/2" Square Drive	121	68	31	23.6	599

Fixtured Spindles

On board servo module, Patented daisy chain, Twin Torque transducer, Twin Angle Encoder

- Long Service Life, Maximum Precision, High Accuracy, World class free speed, On-Board trouble shooting
- Floating adapter not included with spindle



Model	Torque Range				Free Speed r/min	Float mm	Drive Type	Min Center to Center mm	Weight		Length	
	Min Nm	Max Nm	Min Ft lb	Max Ft lb					Lb	kg	in	mm
947548A1	2	12	1.48	8.9	1921	50	3/8" Square Drive	43	13	5.9	15.5	393
947560A5	5	35	3.69	25.8	727	50	3/8" Square Drive	43	13	5.9	15.5	393
947572A1	15	53	11.1	39.1	427	50	3/8" Square Drive	43	13	5.9	15.5	393
947520A3	25	110	18.5	81	890	50	1/2" Square Drive	56	21.4	9.7	18.3	464
947532A9	40	200	29.5	148	502	50	3/4" Square Drive	56	21.4	9.7	18.3	464
947584A7	50	300	36.9	221	453	50	3/4" Square Drive	81	40.1	18.2	20.8	528
947596A3	100	500	74	369	254	50	3/4" Square Drive	91	56	25.5	26.5	674
947610A4	130	660	96	487	174	50	1" Square Drive	91	56	25.5	26.5	674
947620A21	320	1250	236	922	86	50	1" Square Drive	121	75	34	28.6	726
947624A81	400	1600	295	1180	68	50	1-1/2" Square Drive	121	75	34	28.6	726

On board servo module, Patented daisy chain, Twin Torque transducer, Twin Angle Encoder

- Long Service Life, Maximum Precision, High Accuracy, World class free speed, On-Board trouble shooting
- Floating adapter not included with spindle



Model	Torque Range				Free Speed r/min	Float mm	Drive Type	Min Center to Center mm	Weight		Length	
	Min Nm	Max Nm	Min Ft lb	Max Ft lb					Lb	kg	in	mm
947550A7	2	12	1.48	8.9	1825	50	3/8" Square Drive	35	14.1	6.4	15	382
947562A3	5	35	3.69	25.8	690	50	3/8" Square Drive	35	14.1	6.4	15	382
947574A9	15	53	11.1	39.1	405	50	3/8" Square Drive	35	14.1	6.4	15	382
947524A9	25	110	18.5	81	831	50	1/2" Square Drive	44	24.9	11.3	19.2	487
947536A5	40	200	29.5	148	468	50	3/4" Square Drive	44	24.9	11.3	19.2	487
947586A5	50	300	36.9	221	421	50	3/4" Square Drive	59	42.5	19.3	20.6	523
947598A1	100	500	74	369	238	50	3/4" Square Drive	76	60	27	25.2	639
947612A2	130	660	96	487	163	50	1" Square Drive	76	60	27	25.2	639
947616A8	160	750	118	554	135	50	1" Square Drive	76	61	27.5	25.2	639

- The transducer can be rotated for crowded multiple spindle arrangements (DGD 15° radial toothing).
- Floating adapter not included with spindle



Model	Torque Range				Free Speed r/min	Float mm	Drive Type	Min Center to Center mm	Weight		Length	
	Min Nm	Max Nm	Min Ft lb	Max Ft lb					Lb	kg	in	mm
947549A0	2	12	1.48	8.9	1825	50	3/8" Square Drive	35	12.8	5.8	15	382
947561A4	5	35	3.69	25.8	690	50	3/8" Square Drive	35	12.8	5.8	15	382
947573A0	15	53	11.1	39.1	405	50	3/8" Square Drive	35	12.8	5.8	15	382
947523A0	25	110	18.5	81	831	50	1/2" Square Drive	44	22.5	10.2	15.4	390
947535A6	40	200	29.5	148	468	50	3/4" Square Drive	44	22.5	10.2	15.4	390
947585A6	50	300	36.9	221	421	50	3/4" Square Drive	59	37.9	17.2	16.2	412
947597A2	100	500	74	369	238	50	3/4" Square Drive	76	53	24	20.2	512
947611A3	130	660	96	487	163	50	1" Square Drive	76	53	24	20.2	512
947615A9	160	750	118	554	135	50	1" Square Drive	76	54	24.5	20.2	512

On board servo module, Patented daisy chain, Torque transducer, modular construction

- Long Service Life, Maximum Precision, High Accuracy, World class free speed, On-Board trouble shooting
- Floating adapter not included with spindle



Model	Torque Range				Free Speed r/min	Float mm	Drive Type	Min Center to Center mm	Weight		Length	
	Min Nm	Max Nm	Min Ft lb	Max Ft lb					Lb	kg	in	mm
947552A5	2	12	1.48	8.9	1801	25	3/8" Square Drive	52	15	6.8	17.7	450
947564A1	5	35	3.69	25.8	681	25	3/8" Square Drive	52	15	6.8	17.7	450
947576A7	15	53	11.1	39.1	400	25	3/8" Square Drive	52	15	6.8	17.7	450
947528A5	25	110	18.5	81	838	25	1/2" Square Drive	59	21.4	9.7	20.4	518
947540A9	40	200	29.5	148	472	25	3/4" Square Drive	59	21.4	9.7	20.4	518
947588A3	50	300	36.9	221	437	25	3/4" Square Drive	81	48	21.9	24.3	617
947600A6	100	500	74	369	245	25	1" Square Drive	112	70	31.6	26.9	684
947614A0	130	660	96	487	167	25	1" Square Drive	112	70	31.7	26.9	684

Fixtured Spindles

On board servo module, Patented daisy chain, Twin Torque transducer, Angle Encoder

- Long Service Life, Maximum Precision, High Accuracy, World class free speed, On-Board trouble shooting
- Floating adapter not included with spindle



Model	Torque Range				Free Speed r/min	Float mm	Drive Type	Min Center to Center mm	Weight		Length	
	Min Nm	Max Nm	Min Ft lb	Max Ft lb					Lb	kg	in	mm
947551A6	2	12	1.48	8.9	1801	25	3/8" Square Drive	52	13.7	6.2	14.6	370
947563A2	5	35	3.69	25.8	681	25	3/8" Square Drive	52	13.7	6.2	14.6	370
947575A8	15	53	11.1	39.1	400	25	3/8" Square Drive	52	13.7	6.2	14.6	370
947527A6	25	110	18.5	81	838	25	1/2" Square Drive	59	21.4	9.7	16.6	421
947539A2	40	200	29.5	148	472	25	3/4" Square Drive	59	21.4	9.7	16.6	421
947587A4	50	300	36.9	221	437	25	3/4" Square Drive	81	43.7	19.8	19.9	506
947599A0	100	500	74	369	245	25	1" Square Drive	112	63	28.6	21.9	556
947613A1	130	660	96	487	167	25	1" Square Drive	112	63	28.7	21.9	556

Contact the application center for other cable lengths not listed

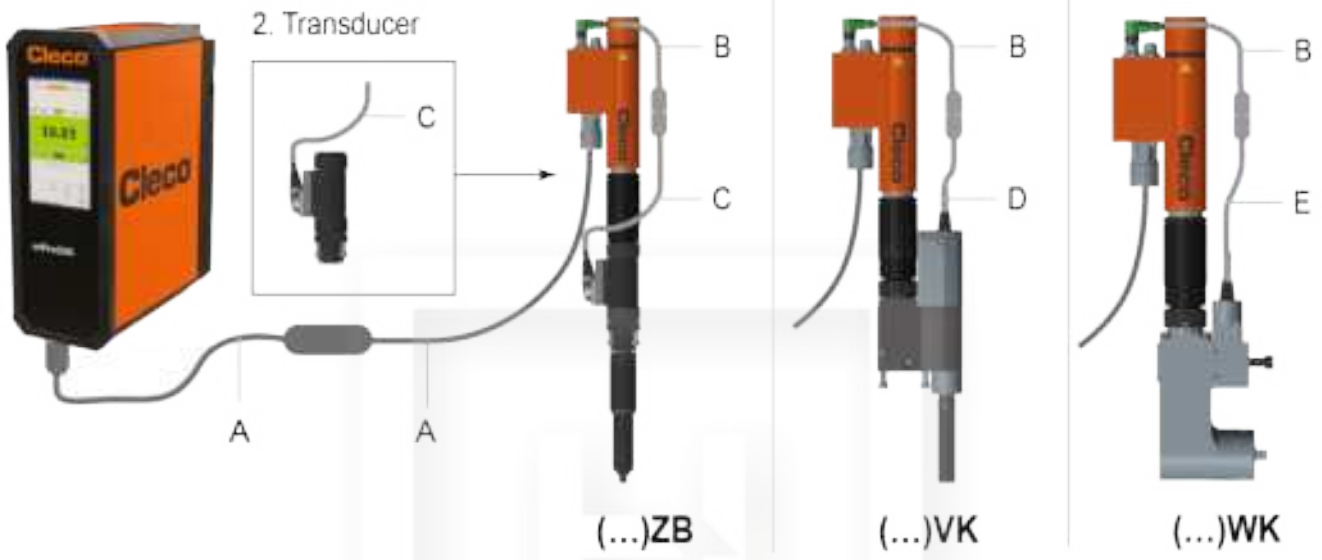

A	Size	ATT584387	ATT661684	B	C	D	E
		Length					
Order Number		Meters	Feet	Order Number	Order Number	Order Number	Order Number
961561-010	1	1	3	952343-002	9472769PT-002	9472769PT-002	943825PT-002
961561-060	1	6	19.5				
961561-250	1	25	82				
961923-010	2	1	3	952343-002	9472769PT-002	9472769PT-002	943825PT-002
961923-060	2	6	19.5				
961923-340	2	34	102				
961923-010	3	1	3	952343-003	9472769PT-002	9472769PT-002	943825PT-002
961923-060		6	19.5				
961923-340	3	34	102				
961923-010	4	1	3	952343-005	9472769PT-002	9472769PT-002	943825PT-002
961923-060		6	19.5				
961923-340	4	34	102	952343-007 (472800)			

Fixtured Spindles

Model	Motor Size	Torque Range Max		X Dimension
		Ft Lb	Nm	in mm
S308434	1	44.3	60	6.61 168
S308435	2	118	160	6.77 172
S308436	3	384	520	6.92 176
S308437	1	44.3	60	6.61 168
S308438	2	81	110	6.55 166.5
S308439	3	221	300	6.73 171
S308440	4	384	520	6.88 175
S308450	2	148	200	6.77 172
S308474	4	487	660	6.73 171
S308475	2	148	200	6.55 166.5

- For fixed or flexible routing with heavy-duty requirements in applications with cable drag chain or standard robot applications.

Model	Length	
	ft	m
961104-030	9.8	3
961104-040	13.1	4
961104-050	16.4	5
961104-060	19.7	6
961104-070	23	7
961104-080	26.2	8
961104-090	29.5	9
961104-100	32.8	10
961104-150	49.2	15
961104-200	65.6	20
961104-300	98.4	30
961104-400	131.2	40
961104-500	164.1	50



Fixtured Spindles

Model	Length	
	ft	m
961204-005	1.6	0.5
961204-010	32.8	1
961204-020	65.6	2
961204-100	328.1	10
961204-120	393.7	12
961204-150	492.2	15
961204-200	656.2	20
961204-300	984.3	30



Model	Length	
	ft	m
96169-150	492.2	15



Fixtured Spindles

- Highflex Type D Jumper straight connector on both sides
- Moulded connector housing

Model	Length	
	ft	m
961104-005	1.6	0.5
961104-010	3.3	1
961104-020	6.6	2

The cable lengths are specified in decimeters at the end of the order number.
Other cable length on request.



- Highflex Type E Jumper 90° connector on both sides
- Rotatable cable glands

Model	Length	
	ft	m
961299-005	1.6	0.5
961299-010	3.3	1
961299-020	6.6	2

The cable lengths are specified in decimeters at the end of the order number.
Other cable length on request.



Overview of possible numbers of channels

The maximum number of Intelligent Spindles per mPro400GC Controller depends on load. When calculating the maximum number of spindles, please consider the following conditions:

Maximum speed at 20% of maximum torque (at 1BTSE, 2BTSE, 3BTSE and 4BTSE)

Final tightening stage up to 500 Nm Maximal Speed 50 rpm at maximum torque (at 1BTSE, 2BTSE, 3BTSE and 4BTSE-4B500A...)

Final tightening stage over 500 Nm Maximal Speed 20 rpm at maximum torque (at 4BTSE-4B660A..., 4BTSE-4B660A-4VK4MS, 4BTSE-4B360A-4Z1250A and 4BTSE-4B460A-4Z1600A)

If higher settings are chosen, number of channels should be reduced.

If different spindle types are used at the controller, the number of channels will be individually defined.

Please contact Apex Tool Group.

Model	Motor Size	Torque Range Max		X Dimension in mm
		Ft Lb	Nm	
S308434	1	44.3	60	6.61 168
S308435	2	118	160	6.77 172
S308436	3	384	520	6.92 176
S308437	1	44.3	60	6.61 168
S308438	2	81	110	6.55 166.5
S308439	3	221	300	6.73 171
S308440	4	384	520	6.88 175
S308450	2	148	200	6.77 172
S308474	4	487	660	6.73 171
S308475	2	148	200	6.55 166.5

Fixtured Spindles

Model	Motor Size	Torque Range Max		X Dimension
		Ft Lb	Nm	in mm
910609	2	118	160	7.08 180
910613	3	384	520	7.28 185
912106	4	384	520	7.48 190
912147	4	554	750	7.32 186
916642	4	465	630	7.28 185
916643	4	384	520	7.48 190
922325PT	1	44.3	60	7.08 180
935552	2	148	200	7.08 180
S308441	4	1181	1600	5.31 140
S976956	4	554	750	5.31 140



Model	Motor Size	Torque Range Max		X Dimension
		Ft Lb	Nm	in mm
S308434	1	44.3	60	6.61 168
S308435	2	118	160	6.77 172
S308436	3	384	520	6.92 176
S308437	1	44.3	60	6.61 168
S308438	2	81	110	6.55 166.5
S308439	3	221	300	6.73 171
S308440	4	384	520	6.88 175
S308450	2	148	200	6.77 172
S308474	4	487	660	6.73 171
S308475	2	148	200	6.55 166.5

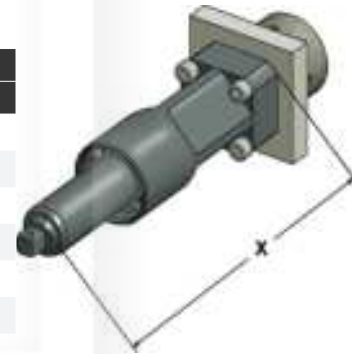

Model	Motor Size	Torque Range Max		X Dimension
		Ft Lb	Nm	in mm
929041	1	44.3	60	2.95 75
929053	2	125	170	3.54 90
929061	2	148	200	4.52 115
929065	3	221	300	4.13 105
929077	4	384	520	4.52 115
929089	4	487	660	4.52 115

